

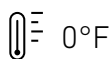

Ventilated freezer display case.

Fixed double glazed glass case | "black" silkscreen printing | polished aluminium profiles | nr. 3 intermediate shelves with lighting adjustable on low-voltage electri-fied rack system | operator-side closing with double-glazed glass sliding doors | heated front glass | tank insulated with ecological polyurethane and covered with stainless steel | ventilated refrigeration on each display level | built-in hermetic condensing unit | automatic reverse-cycle defrost | electronic control unit and digital temperature reader | display trays in polished steel | supporting frame display trays in polished steel | supporting frame in galvanized steel with height-a-djustable stainless steel feet

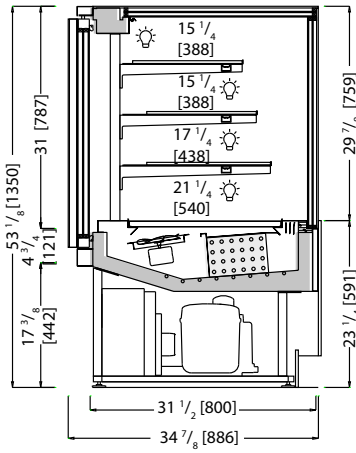







Technical



-  Ventilated
-  R452A
-  Hermetic / 2
-  Led no-spot 3000°K
-  Automatic / reverse cycle
-  N. 3 / H.R. 60% max 75 °F
-  220 V / 3 Ph / 60 Hz
-  0°F

Data Sheet *Measurements are subject to revisions/updates, please refer to manufacturer's drawings at order confirmation  *Crate weight only

Model Code	Dimensions L x D x H Inches	Weight Lbs	Max Pwr. Consumption W / A	Avg Operating Consumption KW/H	Cooling Power/Expansion BTU / °F	GAS Type
 TRT3P8GEL1201	47 1/4 x 34 7/8 x 53 1/8	595	2400 / 12.1	1.6	3242 / -31	R452A
	 54 5/16 x 41 15/16 x 63 3/4	 265				

Optionals:

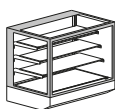

SERIG01
Serigraphy
RAL color

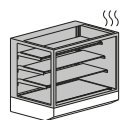

TRTVC01
Heated glass

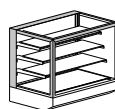

BRDTR01-02
Inox profiles

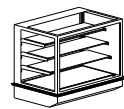

CIVF117
Perimetral top for
drop-in config.

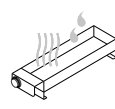

CIT16
Condensation
water pan

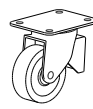

CIM08
Kit wheels