

6040 P8 GEL R4 H1350

CIAM



Gelato Showcase.

Glass structure with mechanical fastening | heated glass sides | bright aluminum LED light fixture | PETG easy sliding doors system | anti-fog air baffle | Tank insulated with ecological polyurethane and covered in stainless steel | ventilated refrigeration with increased "delivery port" | reverse cycle defrost | electronic control unit and digital temperature reader flush with the worktop | worktop and perimeter shelf in polished steel | pre-arrangement for 5lt pans dim. $14 \frac{1}{16} \times 6 \frac{7}{16} \times 4 \frac{11}{16}$ [360 x 165 x 120] or 4lt pan dim. $10 \frac{3}{16} \times 6 \frac{5}{16} \times 7 \frac{7}{8}$ [258 x 160 x 150] not supplied | supporting frame in galvanized steel with height adjustable stainless steel feet | technical compartment and open compartment in polished stainless steel



 0°F

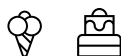

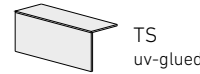
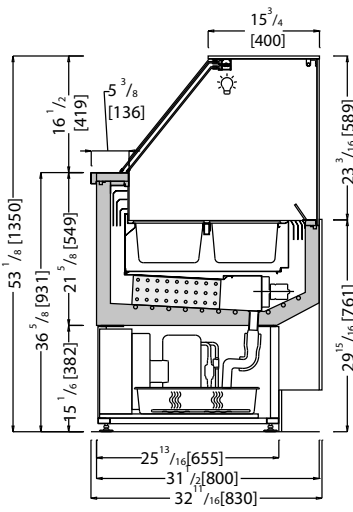

TS
uv-glued

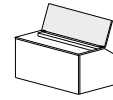

R4UP
lift-up top glass

Technical



Ventilated



Automatic / reverse cycle



R452A



N. 4 / RH 55% max
75 °F)



Hermetic



220 V / 3 Ph / 60 Hz



Led no-spot 3000°K



0°F

Data Sheet

*Measurements are subject to revisions/updates, please refer to manufacturer's drawings at order confirmation



*Crate weight only

Model Code	Dimensions L x D x H Inches	Weight Lbs	Max Pwr. Consumption W / A	Avg Operating Consumption KW/h	Cooling Power/Expansion BTU / °F	GAS Type
 SQ8R413GL12I (+PANELS)	45 1/4 x 32 11/16 x 53 1/8 51 15/16 x 39 3/4 x 64 9/16	397 240	1700 / 9.0	0.9	1911 / -31	R452A
 SQ8R413GL18I (+PANELS)	64 15/16 x 32 11/16 x 53 1/8 71 5/8 x 39 3/4 x 64 9/16	573 331	2200 / 11.5	1.2	2593 / -31	R452A
 SQ8R413GL24I (+PANELS)	84 5/8 x 32 11/16 x 53 1/8 91 5/16 x 39 3/4 x 64 9/16	661 423	2700 / 14.0	1.8	3071 / -31	R452A

Optionals:



CIV61
s/s pan inches
14 1/16 x 6 7/16 x 4 11/16
[360x165x120]



CIV63
s/s pan inches
14 1/16 x 9 3/16 x 3 3/16

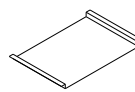

CIVF95
s/s display tray

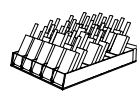

GSG02
Perspex pan

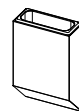

CIV56
s/s dipper well

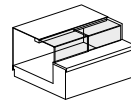

SCORTF01-03
L-shaped doors



PASPRA
Switch from
-0.4°F to +39.2°F

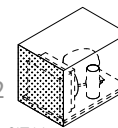

CIT44
Easy Clean Filter

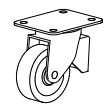

CIM08
Kit wheels